

## THERMAX fire protection

# MANUAL

PRODUCT THERMAX B-0 Class suspended CEILING/  
THERMAX A-15 class deck

BOARD THERMAX SN  
> Technical data sheet

MANUFACTURING DOCUMENTATION  
> Design details  
> Handling instructions

### TYPE EXAMINATION CERTIFICATES

No. 08220 MED B-0 Class Suspended Ceiling THERMAX SN/ A-15 Class Deck  
No. 08905 MED Non-combustible materials  
No. SMS.MED2.D/17 Quality system Module D

# TECHNICAL DATA SHEET - THERMAX® fire protection boards

## PRODUCT DESCRIPTION:

**THERMAX®** are non-combustible Vermiculit boards with smooth surface and in large size; characterized by particularly easy and clean processing.

The sanded boards are especially suitable for further decorative processing.

**THERMAX®** offers sustainable, future-oriented products for fire protection.



## THERMAX® fire protection board types

### Technical specification \*

Type	SN
Reaction to fire classification (EN 13501-1)	A1
Reaction to fire (IMO Res. MSC 307(88) FTP (2010))	Non-combustible
Density [kg/m³] [Tolerance: +/-10%]	800
Standard dimension or on request [mm]	2440 x 1220   2500 x 1250   2800 x 1250   3050 x 1250**
Tolerance in dimension [mm]	+/- 2.0
Standard thickness or on request [mm]	8**, 10, 12, 16, 19, 22, 25, 28, 30
Tolerance in thickness [mm]	+/-0.3***
Bending strength (EN 12809 Var.B) [MPa]	4
Tensile strength (EN 319)	0.4
Residual moisture (ex works) [%] (EN 322)	2 - 6

\* The shown values are always dependent on the particular density and provide minimum or average values of the production. Safety data sheet and manual are available on request. All technical data are due to changes and supplements.

\*\* Dimension 3050x1250 mm not available in thickness 8 mm

\*\*\* Sanded board type.

### Application areas

**THERMAX®** fire protection boards are used successfully for many years. As a carrier board with all approved covering materials for use as decorative fire protection board in interior design or in the international shipbuilding. They are especially suitable for interior walls, ceilings, wall coverings, furniture, etc.

## Design details

B-0 class suspended ceiling/ A-15 class deck made of 10 mm thick THERMAX SN boards.

Maximum panel dimension: 600 x 2420 mm (width x length).

Maximum distance between hangers: 1200 mm

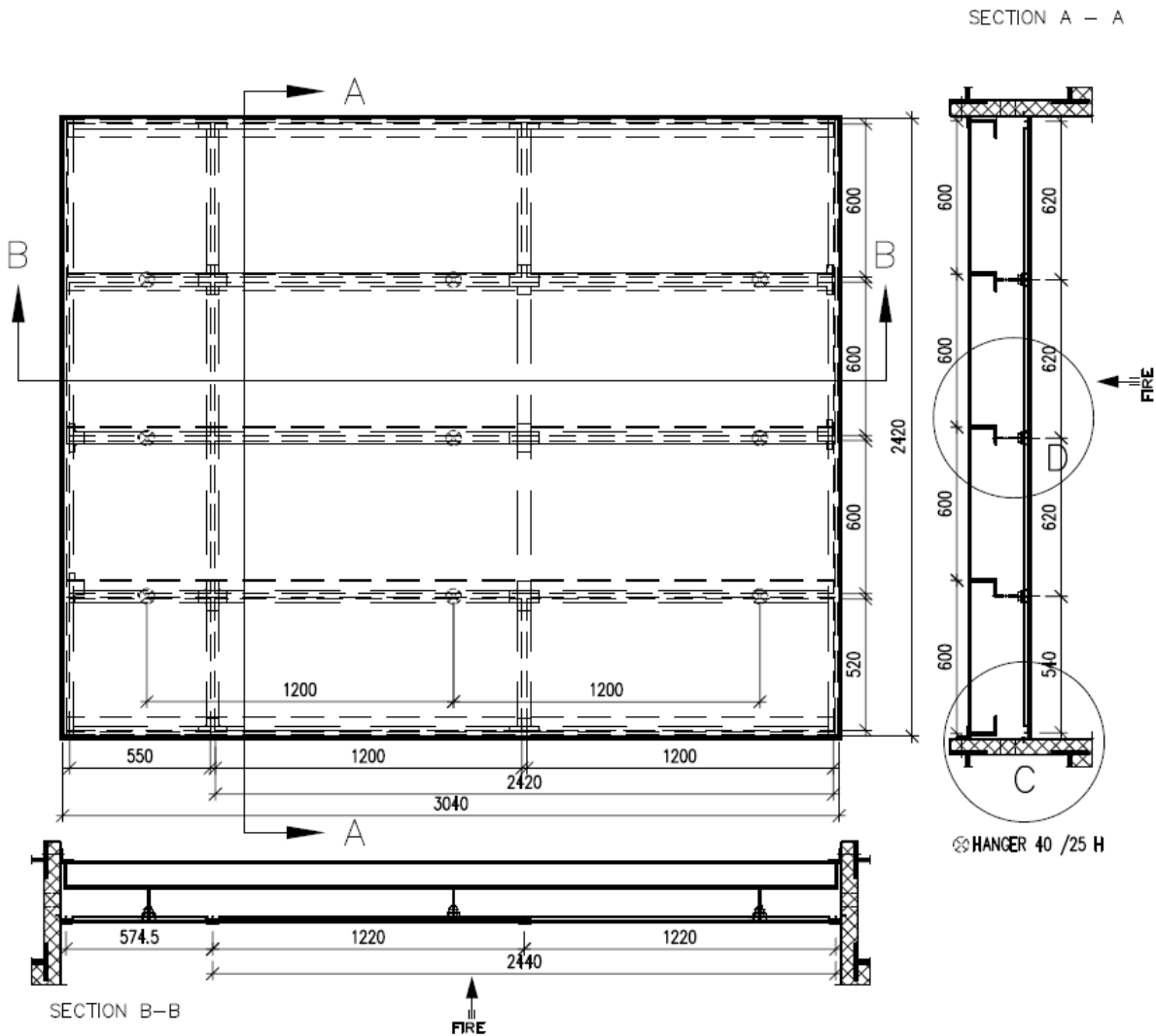

Ceiling is suspended under a structural deck with a distance of 240 mm by hangers type HG 40/25 H welded on C-profiles at a distance of 620 mm longitudinally and 1220 mm transversally.

Ceiling framework is connected with deck by means of M8 threaded rods, welded to the hangers and to the deck stiffeners.

Ceiling framework is made of:

- inner 1.5 mm thick steel C-profiles (15 x 50 15 mm) fixed to each other by steel T-shaped cross connectors (deckhead mounting section 150 x 15 x 1.5 mm),

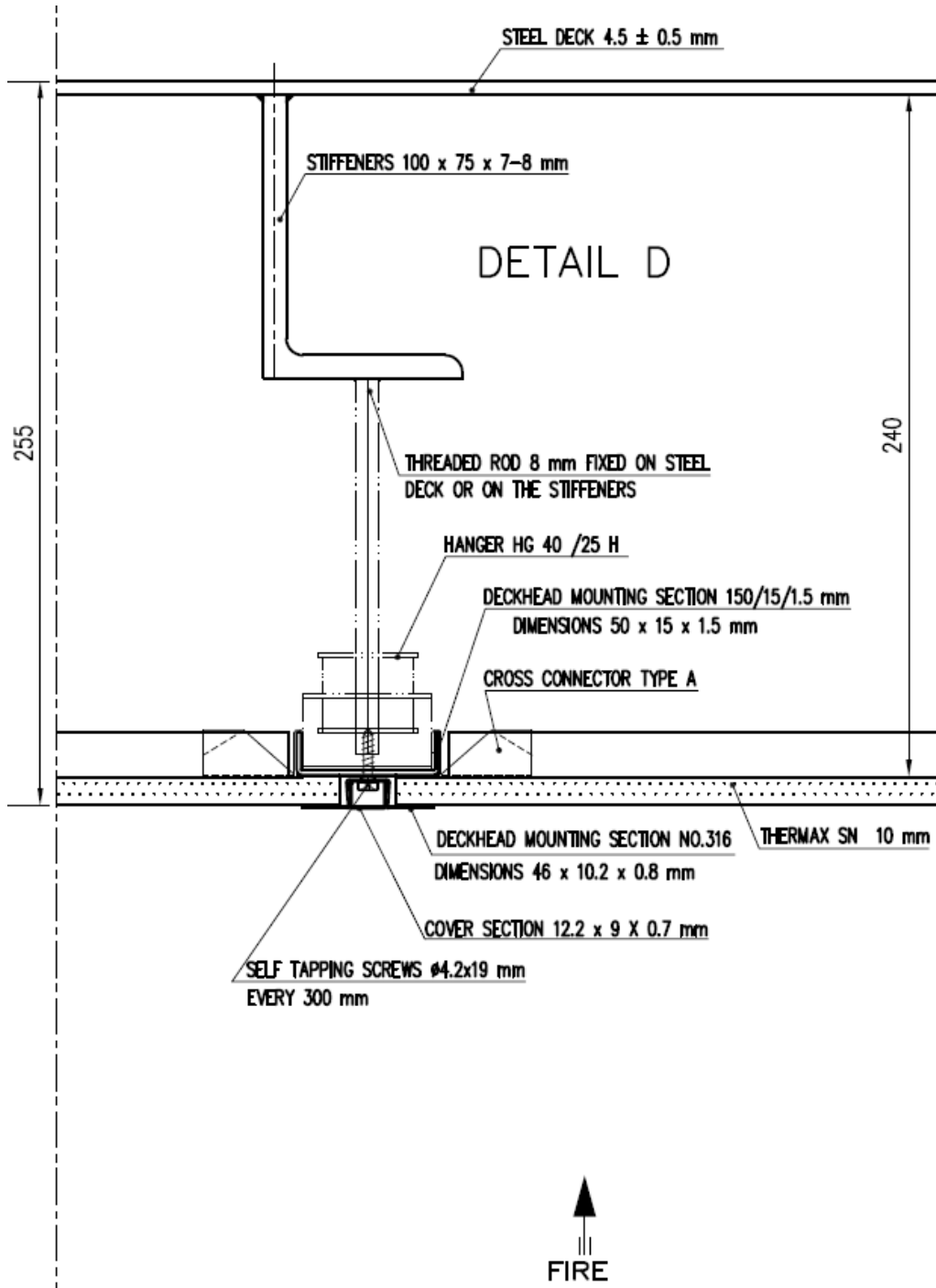



DECKHEAD MOUNTING SECTION  
150/15/1.5 mm

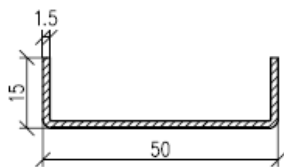

DECKHEAD MOUNTING SECTION  
150/30/15/1.5 mm

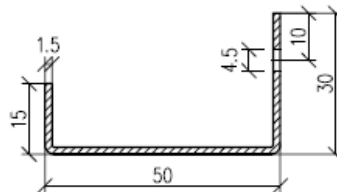

DECKHEAD MOUNTING SECTION NO.316 COVER SECTION 12.2 x 9 X 0.7 mm

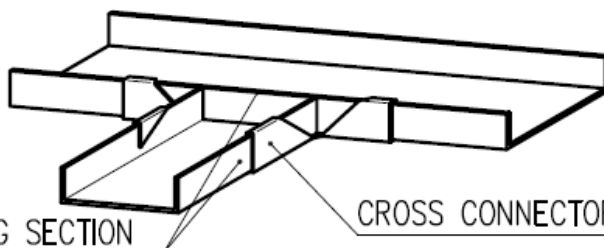
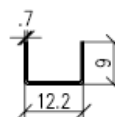
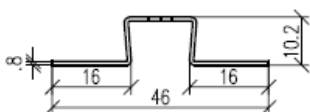

DECKHEAD MOUNTING SECTION  
150/15/1.5 mm

CROSS CONNECTOR TYPE B

DECKHEAD MOUNTING SECTION  
150/15/1.5 mm

CROSS CONNECTOR TYPE A

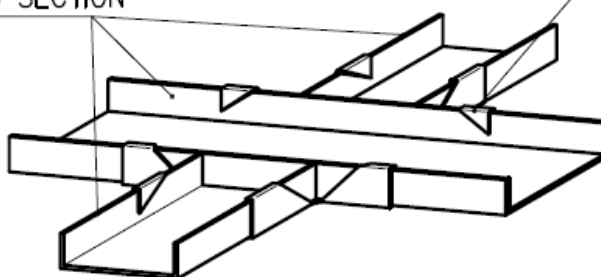

CROSS CONNECTOR TYPE A

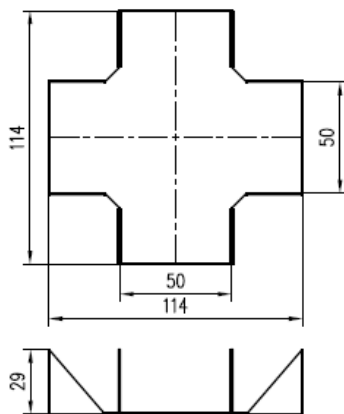

CROSS CONNECTOR TYPE B

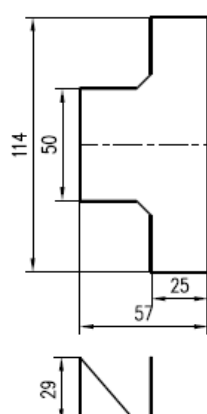

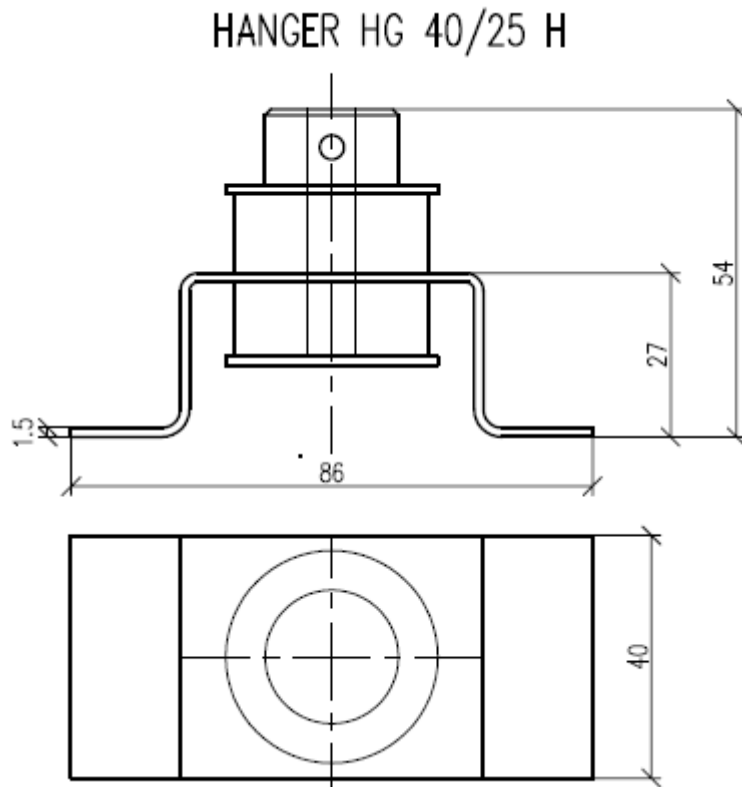

## Handling with THERMAX fire protection boards

### GENERAL INFORMATION

Fire protection constructions made of THERMAX boards are on a high level of processing technology today.

In order to ensure the quality standard also at installing THERMAX fire protection constructions, consider the following recommendations and instructions for handling and processing.

#### Internal Transport

For transport with fork lift, a fork size of more than 90 cm is recommended. In any case a sufficiently thick underlying surface shall be used.

Single boards have to be carried vertically, meaning upright, by 2 people.

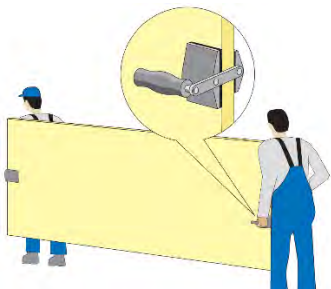

#### Tools and machines

THERMAX boards can be safely processed with conventional tools and machines and without any issues regarding work hygiene or environmental impact (drilling, milling, sawing, sanding, etc.).

- > For cutting boards, wood cutting machines with cutters that have typical carbide teeth.
- > Edge work for large quantities can be done with a double end profiler. The machining equipment is similar to those used for chipboards. The feed rate should be slightly reduced.

#### GENERAL INDICATIONS

THERMAX fire protection boards can be finished with all known surface materials. The choice of a suitable adhesive is determined, on the one hand, according to the different characteristics and, on the other hand, according to the local conditions at the processing plant (mechanical equipments, etc.). The purpose for which the faced elements are to be used, the climatic conditions at the place of destination and the relevant fire service regulations are also to be considered.

#### Choice of carrier board

The different mechanical properties of THERMAX boards (types SN, SN650 or SN850) are to be considered for applying the different surface material.

For standard HPL as from 0.8 mm thickness, for HPL with glossy surfaces, for real-wood veneers and, in general, for all applications in maritime interior fittings, we recommend the board type THERMAX SN.

For thicker, matt laminates and harder coatings and wherever it is approved in marine interior fittings for walls or ceilings, also the somewhat lighter board THERMAX SN650 is suitable.

For lamination with foils, for thin laminates and for real-wood veneers and especially for the fabrication of furniture components we have developed the higher-density board type THERMAX SN850.

The light board type THERMAX SN400 are not suitable for being bonded with laminates or veneers. These boards, amongst other things, are also applied as infills for fire-protection doors.

#### Humidity content and conditioning

The humidity content of THERMAX fire protection boards ex-works is app. 2 to 6 %. This original humidity content can change during transport and temporary storage.

*Therefore, it is an important condition for good adhesion that before bonding, the carrier and facing material be freely conditioned for long enough, in an air-conditioned area.*

- > The environmental humidity for raw and finished products should be app. 60% relative air humidity.
- > Air-conditioned or evenly heated workshops with a temperature of app. +20°C are an advantage.
- > *Optimally balanced humidity is reached after app. 7 days.*

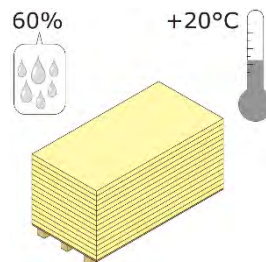

#### Board surfaces

The THERMAX boards (types SN, SN650 and SN850) are supplied factory-side rough-sanded.

The thickness tolerance in a board is +/- 0.3 mm.

## Handling with THERMAX fire protection boards

This surface is very ideally suited for facing with HPL, starting from a min. thickness of 0.8 mm (except high-glossy laminate). Before applying the adhesives, the front and reverse sides of the raw boards are to be mechanically or manually cleaned of any possible granulate residues and freed of dust (by brushing and vacuuming). Also, it must be ensured that the surfaces are absolutely grease free.

For veneering and facing with high-glossy and/or thin laminates, we recommend calibrating the boards, i.e. sanding them before applying the adhesive. A good surface is produced using a granulation 80-100 sanding belt.

It is advisable, depending on the kind and type of facing material, to run preliminary tests.

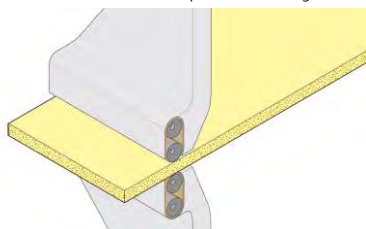

The surface of the THERMAX fire protection boards is to a large extent chemically neutral. Therefore, no special adhesives or primers are necessary.

### ASSEMBLY OF THE ELEMENTS

#### Symmetrical assembly

When facing with laminated material (HPL), as also when veneering, materials with exactly the same shrinkage and swelling characteristics must always be used on both faces of the carrier board.

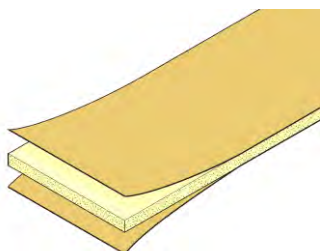

#### Symmetry with laminated materials

Obligatory instructions for laminated materials are to be found in the ICDL (International Committee of the Decorative Laminates Industry) guidelines and from the GKV (specialized group on decorative laminated material boards of the General Association of the Plastics Processing Industry, Germany).

Not only is the same laminate thickness important but the following are also decisive for optimum symmetry:

- the laminate structure (carrier and decorative papers as well as overlays and protection foils).
- the surface texture.
- the graining of the decorative papers.
- the direction in which the decorative papers are laid.
- the humidity content of the HPL.
- the age of the laminates.

So never use just pure counterbalancing laminates from any residual stocks or laminated materials with sanded, roughened décor sides for backing the boards. An ideal solution is using décor laminates on both sides, i.e. the same laminates for the reverse side as for the decorative side, from the same production (ask for décor laminates "B" quality which may have slight deficiencies in the décor).

#### Symmetrical veneering

When using genuine wood veneers, related types of woods must be used for both, front and reverse side. Both surface facings must absolutely have the same shrinking and swelling properties.

### PRESSING PROCEDURE

#### Choice of adhesive

The decision as to what adhesive to use depends on a large extent on

- the composite material (glue) to the carrier board,
- the area of application,
- the possible gluing procedure depending on the technical conditions offered by the processor (type of press, heating device, glue spreading).

Then there is the important role of the local climatic conditions and the resulting

- pot life,
- open time,
- shelf life of the adhesive.

*In any case, the regulations concerning fire protection and especially whether the glue also has to be tested and approved, have to be considered!*

The criteria differ depending on the type of glue used. So the data in the respective glue manufacturers' instruction sheets are decisive.

## Handling with THERMAX fire protection boards

Many producers consider the characteristics of mineral substrates. Give your preference to these manufacturers or have your supplier himself conduct preliminary tests.

To guarantee and increase the absolutely necessary minimum elasticity of the glued joints, urea resins can be supplemented with appropriate extenders (e.g. industrial flour). "Modified" urea resins are recommendable.

### Laminate compression

Apart from general and special cabinet-making rules as well as the instructions of the respective HPL producers, the publications, recommendations and guidelines of the trade associations mentioned under "Symmetry with laminated materials" also apply.

In principle, both procedures are possible:

- > Hot pressing in the multi-platen or short-cycle press, or
- > cold pressing in the block press.

Particularly with the hot-pressing procedure, special care must be taken to ensure that the laminated material protrudes of the raw carrier board by no less than 10 mm and no more than 15 mm all around. Likewise, 10-15 mm must be allowed for trimming all round.

*Based on own experience we implicitly prefer the cold-press procedure in the block press, with PVAc glues.*

### Applying the glue

Conventional glue-spreaders can be used, e.g. two- or four-roller glue-spreading machines; automatic spray guns or manual spreaders such as serrated spatulas and hand spray pistols.

An ideal film of glue is obtained with a four-roller spreader, while hand spreading requires special care.

### Quantity of glue

You must follow in first place the instructions and recommendations of the glue manufacturer. The exact glue quantities have to be determined by pre-tests.

### HOT PRESSING PROCEDURE

Examples of glue types

Provided that no special fire protection directives concerning the use of certain glue products are required (e.g. non-combustibility), basically the gluing with

- condensation resin glues, i.e. urea resins, as well as
  - dispersion glues, i.e. PCVc glues
- are suitable.

Press temperature when facing with HPL

Under normal circumstances, we do not recommend temperatures above +50 - 60°C. Excessive temperatures and press times cause the glue to harden prematurely. Moreover, high temperatures cause stress in the HPL, which leads to distortions and overstressing of the bond between the carrier board and the HPL.

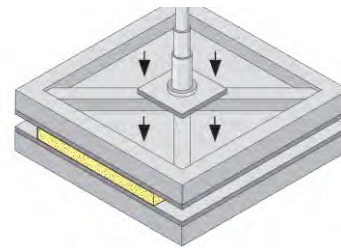

Press times

The pressure should be 0.1 to 0.4 N/mm<sup>2</sup>.

The press time depend on type of glue and temperature. Short press times are to be preferred but not, however, at the cost of higher temperatures.

Consider the open and closed waiting periods!

### COLD PRESSING PROCEDURE

*Preference is to be given to this procedure when pressing laminated materials! The advantage of the cold procedure clearly lies in the careful treatment of the carrier and facing materials.*

Even with cold pressing procedure, 10-15 mm must be allowed for trimming all round.

Examples of glue types

Provided that no special fire protection directives concerning the use of certain glue products are required (e.g. non-combustibility), basically the gluing with

## Handling with THERMAX fire protection boards

- condensation resin glues, i.e. urea resins, as well as
  - dispersion glues, i.e. PCVc glues
- are suitable.

*For applications in marine interior fittings, tested and approved glues have to be used. Based on experience we recommend PVAc glues.*

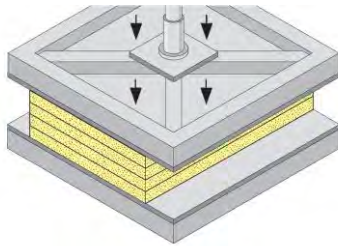

### Press temperatures

Press, room and material temperatures should not fall below +20°C.

### Press times

The pressure should be 0.2 to 0.4 N/mm<sup>2</sup>.

The press time depend on the above mentioned press, room and material temperatures and the type of glue (follow processing guidelines). It has been found that even with small temperature differences, different press times are necessary.

### SUBSEQUENT TREATMENT

#### Curing and rest time

The decision as to what adhesive to use depends on a large extent on

Freshly glued boards are never to be immediately processed, trimmed or cut up. The full strength of the glued joint is reached only after several days. Even when removing from the press, care must be taken not to flex the board.

It is crucial that sufficient time be allowed for the glued joints to harden off after pressing. Further processing too soon can lead to problems.

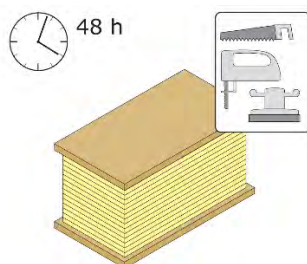

### After cold pressing

It is recommended to leave the boards closely stacked for at least 2 days on an absolutely flat surface, covered by an approx.. 25-30 kg/m<sup>2</sup> weight.

### After hot pressing

Here again, we recommend that the boards be close stacked, on an absolutely flat surface. The boards can cool down slowly under a heat insulating cover. Subsequent processing, such as trimming, cross-cutting, sizing, etc. should take place only after approx. 2-3 days.

Immediately after pressing, the adhesion of the facing material to the THERMAX boards is not yet complete. Water in the glue temporarily weakens the bonding area and the uppermost laminate of the carrier board.

### STORAGE INFORMATION

The THERMAX boards we supply must be absolutely protected from moisture in closed areas and be stored under normal climatic conditions. It is essential to avoid exposing the boards to rapid climatic changes.

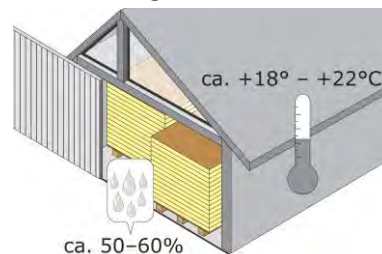

Boards faced, laminated, veneered or coated with HPL may not be exposed to conditions where relative air humidity could drop below 50% or rise above 60%. Air temperatures in stockrooms should not fall below +18°C not rise above +22°C.

### Stacking

To prevent boards from breaking or deforming, the boards must be stacked on pallets or storage lumber at a span of about 30 cm. Storing the boards upright, without good contact on a supporting surface, will lead to deformation, which causes problems for utilization and installation.

No more than 2 original pallets shall be stacked. Pallets in use shall be covered by a e.g. thin particle board and an additional loose film.