



MANUAL

1. PRODUCT: **FIPRO B-0 Class BULKHEAD**

BOARD: **FIPRO 16 mm**

2. MANUFACTURING DOCUMENTATION

- Description
- Drawing: Fipro bulkhead top
- Drawing: Fipro bulkhead bottom
- Drawing: Fipro bulkhead side connections
- Drawing: Fipro bulkhead board connections
- Drawing: Profiles
- Technical data sheet for FIPRO board
- Handling with FIPRO boards

3. TYPE EXAMINATION CERTIFICATES

- Non-combustible materials - Certificate No. 07000 MED
- B-0 Class bulkhead FIPRO - Certificate No. 08219 MED
- Quality system Module D - Certificate No. SMS.MED2.D/17

If certain characteristics are essential for certain applications, it is best to contact us.
We are constantly expanding our construction program. For more information, please visit us at www.fipro.si.



Mineralka d.o.o.
SI-1380 Cerknica

T +386.1.709 00 00
F +386.1.709 00 02

Visit us
www.fipro.si



2. MANUFACTURING DOCUMENTATION

DESCRIPTION

B-0 Class Bulkhead composed of 16 mm boards "**FIPRO**".

Junction between boards consists of:

- two steel □-profiles (30 x 10 x 0.8 mm), fixed together by self-tapping screws (Ø4.2 x 10 mm) with cover sections (7.6 x 8 x 0.8 mm), placed each 300 mm,
- or
- steel spline (25 x 2 mm or 30 x 3 mm) placed in the groove on the long edges of boards for the height up to 2500 mm,
- steel spline (30 x 3 mm) placed in the groove on the long edges of boards for the height over 2500 mm,
- or
- 38 x 3.2 mm folded steel splines (0.8 mm thick) placed in the groove on the long edges of boards.

Framework is made by:

- top profile: steel U-profile (20 x 40 x 1.5 mm) or equivalent construction,
- edge profiles: 2 x steel L-profile (20 x 40 x 1.5 mm) or equivalent construction
- bottom profile: 2 x steel L-profile (20 x 20 x 1.5 mm) or equivalent construction.

Framework is fixed to the structure with L-clamps (255 x 70 x 25 x 2 mm) welded or screwed with 300 mm spacing (on top and bottom edge) and 400 mm spacing (on left and right edge).

BOARD: FIPRO 16 mm

MAXIMUM BOARD WIDTH: 1250 mm

MAXIMUM BOARD HIGHT: 3010 mm with spline 30x 3mm

If certain characteristics are essential for certain applications, it is best to contact us.
We are constantly expanding our construction program. For more information, please visit us at www.fipro.si.



*Mineralka d.o.o.
SI-1380 Cerknica*

*T +386.1.709 00 00
F +386.1.709 00 02*

*Visit us
www.fipro.si*

The content of this catalogue and information about it has been provided in good faith, under the exclusion of liability and shall not form the basis for any warranty claims. The content is provided as assistance to the Mineralka product users and resellers, who are fully responsible for their actions. Stipulations in the official document only are legally binding for the user.



DRAWINGS

BULKHEAD TOP

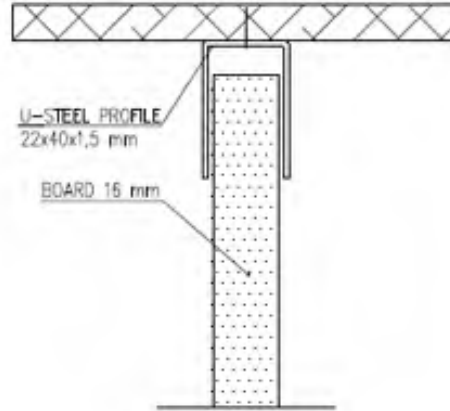
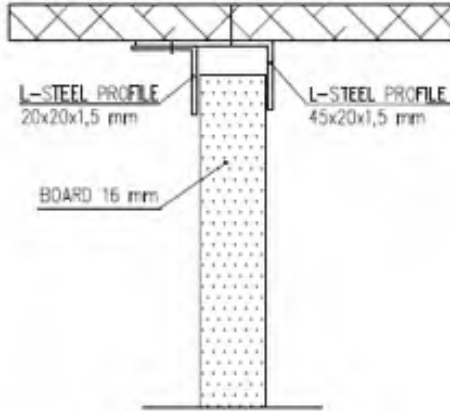

BULKHEAD BOTTOM

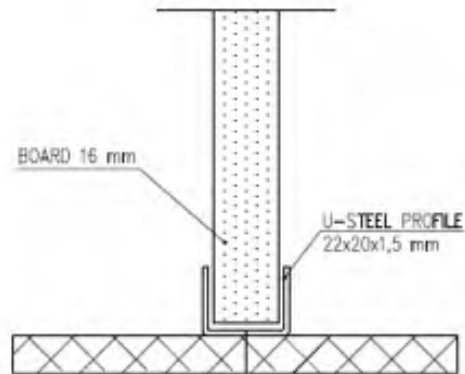
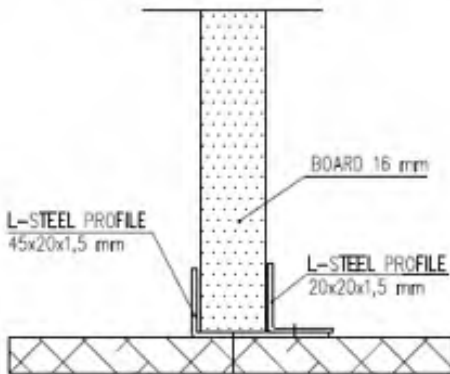

If certain characteristics are essential for certain applications, it is best to contact us. We are constantly expanding our construction program. For more information, please visit us at www.fipro.si.



Mineralka d.o.o.
SI-1380 Cerknica

T +386.1.709 00 00
F +386.1.709 00 02

Visit us
www.fipro.si

The content of this catalogue and information about it has been provided in good faith, under the exclusion of liability and shall not form the basis for any warranty claims. The content is provided as assistance to the Mineralka product users and resellers, who are fully responsible for their actions. Stipulations in the official document only are legally binding for the user.



SIDE CONNECTIONS

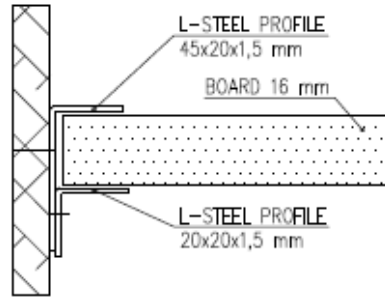
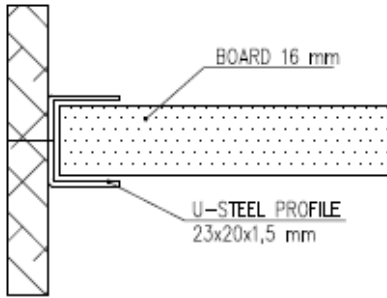

BOARD CONNECTIONS
STEEL SPLINE

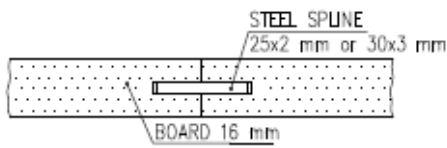

OMEGA STEEL PROFILE

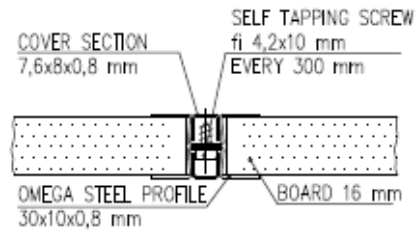

FOLDED STEEL SPLINE

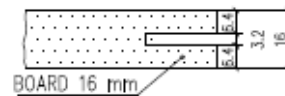
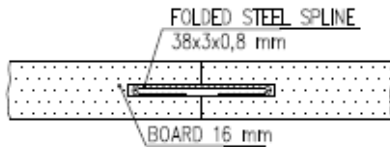

If certain characteristics are essential for certain applications, it is best to contact us.
We are constantly expanding our construction program. For more information, please visit us at www.fipro.si.



Mineralka d.o.o.
SI-1380 Cerknica

T +386.1.709 00 00
F +386.1.709 00 02

Visit us
www.fipro.si

The content of this catalogue and information about it has been provided in good faith, under the exclusion of liability and shall not form the basis for any warranty claims. The content is provided as assistance to the Mineralka product users and resellers, who are fully responsible for their actions. Stipulations in the official document only are legally binding for the user.



PROFILES:

U – STEEL PROFILE 25x40x1,5 mm
Material: zinc coated steel

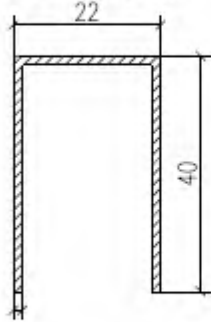

1.5

U – STEEL PROFILE 25x20x1,5 mm
Material: zinc coated steel

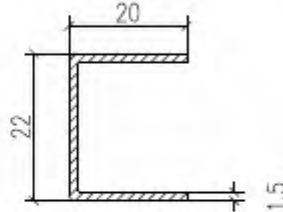

L – STEEL PROFILE 20x20x1,5 mm
Material: zinc coated steel

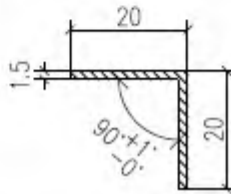

L – STEEL PROFILE 45x20x1,5 mm
Material: zinc coated steel

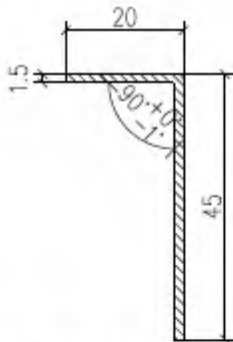

OMEGA STEEL PROFILE 30x10x0,8 mm
Material: zinc coated steel

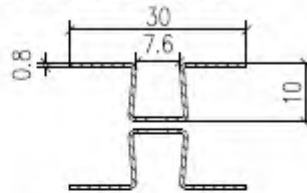

STEEL SPLINE 25x2 mm
Material: zinc coated steel

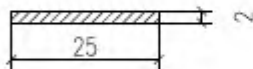

COVER SECTION 7,6x9x0,8 mm
Material: zinc coated steel

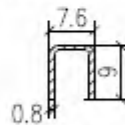

STEEL SPLINE 30x3 mm
Material: zinc coated steel

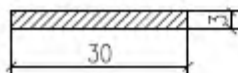

FOLDED STEEL SPLINE 38x3x0,8 mm
Material: zinc coated steel

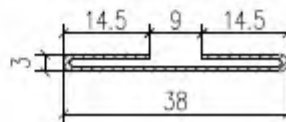

For profiles dimensions is taken into account thickness of the board with HPL - total thickness 18 mm.

If certain characteristics are essential for certain applications, it is best to contact us.
We are constantly expanding our construction program. For more information, please visit us at www.fipro.si.



Mineralka d.o.o.
SI-1380 Cerknica

T +386.1.709 00 00
F +386.1.709 00 02

Visit us
www.fipro.si

The content of this catalogue and information about it has been provided in good faith, under the exclusion of liability and shall not form the basis for any warranty claims. The content is provided as assistance to the Mineralka product users and resellers, who are fully responsible for their actions. Stipulations in the official document only are legally binding for the user.

PRODUCT DESCRIPTION:

FIPRO[®] is a non-combustible Vermiculite board with smooth surface and in large sizes. It is particularly easy and clean for processing. The surface of FIPRO[®] can be covered with many finishing materials.

FIPRO[®]

Technical specification *

Reaction to fire (IMO Res. MSC 307(88) FTP (2010))	Non-combustible
Density	800 kg/m ³ (+/- 10%)
Standard dimension or on request	2440 x 1220 mm 2500 x 1250 mm, 2800 x 1250 mm 3100 x 1250 mm
Tolerance in dimension	+/- 1.0 mm
Standard thickness or on request	8, 10, 12, 16, 19, 22, 25, 30, 32, 40, 50 mm
Tolerance in thickness	+ 0.3/ - 0.2 mm
Bending strength (EN 12809 Var.B)	4.0 MPa
Screw extraction surface and edge** (EN 320)	250 N
Tensile strength (EN 319)	0.3 MPa
Delamination strength (EN 311)	0.8 MPa
Residual moisture (ex works) (EN 322)	2 - 7 %

*All specified technical data are average values from the production and are for information only. Mineralka reserves the right to modify product specifications at any time without notice. Safety data sheet and manual are available on request.

** From thickness 15 mm on.

Packing and weight list

Thickness mm	Weight kg/m ²	Boards/ pallet	
		2440x1250 2500x1250	2800x1250 3100x1250
8	6.8	100	86
10	8.3	80	69
12	9.8	67	58
16	12.6	53	46
19	15.0	49	42
22	17,2	42	36

Thickness mm	Weight kg/m ²	Boards/ pallet	
		2440x1250 2500x1250	2800x1250 3100x1250
25	19.5	37	32
30	23.1	31	26
32	24.6	29	24
40	29.6	23	20
50	37.0	18	16

Application areas

FIPRO[®] non-combustible fire protection boards are used for A, B and C class constructions: bulkheads, ceilings, linings, floating floors, doors and furniture for ships and offshore platforms.

If certain characteristics are essential for certain applications, it is best to contact us. We are constantly expanding our construction program. For more information, please visit us at www.fipro.si.



Mineralka d.o.o.
SI-1380 Cerknica

T +386.1.709 00 00
F +386.1.709 00 02

Visit us
www.fipro.si

The content of this catalogue and information about it has been provided in good faith, under the exclusion of liability and shall not form the basis for any warranty claims. The content is provided as assistance to the Mineralka product users and resellers, who are fully responsible for their actions. Stipulations in the official document only are legally binding for the user.

Handling with FIPRO fire-protection boards

1. Internal Transport

For transport with fork lift, a fork size of more than 80 cm is recommended. In any case a sufficiently thick underlying surface shall be used. Single panels have to be carried vertically, meaning upright, by 2 people.

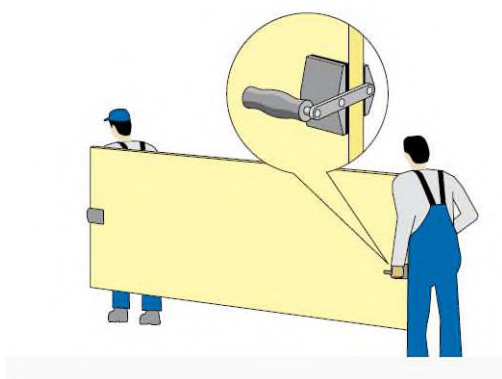

2. Tools and Machines

FIPRO panels can be safely processed with conventional tools and machines and without any issues regarding work hygiene or environmental impact (drilling, milling, sawing, grinding, etc.).

- For cutting panels, wood cutting machines with cutters that have typical carbide teeth.
- Edge work for large quantities can be done with a double end profiler. The machining equipment is similar to those used for chip boards. The feed rate should be slightly reduced.

3. Bonding with laminate

FIPRO fire protection board, can be finished with all known surface materials. The

choice of a suitable adhesive is determined, on the one hand, according to the different characteristics of the carrier and facing material and, on the other, according to the local conditions at the processing plant (mechanical equipment, etc.). The purpose for which the faced elements are to be used, the climatic conditions at the place of destination and the relevant fire service regulations are also to be considered.

3.1 Humidity content

The humidity content of FIPRO fire protection boards ex-works is approx. 2 to 7%. This original humidity content can change during transport and temporary storage.

Therefore it is an important condition for good adhesion that before bonding, the carrier and facing material be freely conditioned for long enough, in an air-conditioned area.

- The environmental humidity for raw and finished products should be approx. 60% relative air humidity.
- Air-conditioned or evenly heated workshops with a temperature of approx. +20°C are an advantage.

•Optimally balanced humidity is reached after approx. 7 days.

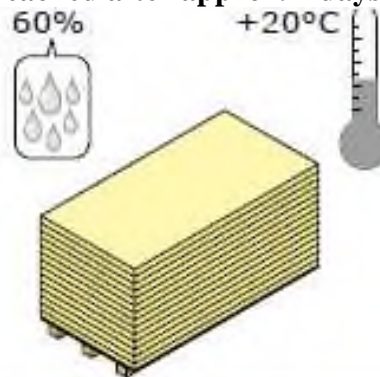

If certain characteristics are essential for certain applications, it is best to contact us. We are constantly expanding our construction program. For more information, please visit us at www.fipro.si.

3.2 Board surfaces

The FIPRO board comes from the factory unsanded. The thickness tolerance of a board is +0.3 mm / -0.2 mm.

This surface is suitable for facing with HPL starting from a min. thickness of 0.8 mm (except high-glossy laminate). Before applying the adhesives, the front and reverse sides of the raw boards are to be mechanically or manually cleaned of any possible granulate residues and freed of dust (by brushing and vacuuming). Also, it must be ensured that the surfaces are absolutely grease free.

For veneering and facing with high-glossy and/or thin laminates, we recommend calibrating the boards, i.e. sanding them before applying the adhesive. A good surface is produced by using a granulation 80-100 sanding belt.

If thicker high-glossy laminate is used, sanding is not necessary.

It is advisable, depending on the kind and type of facing material, to run preliminary tests.

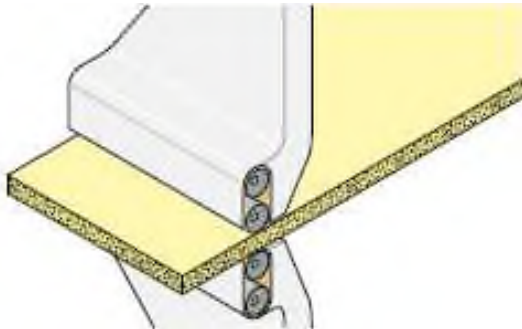

The surface of the FIPRO fire protection boards is to a large extent chemically neutral. Therefore no special adhesives or primers are necessary.

HANDLING

FIPRO® Fire protection boards



4. Assembly of the elements

4.1. Symmetrical assembly

When facing with laminated material (HPL), as also when veneering, materials with exactly the same shrinkage and swelling characteristics must always be used on both faces of the carrier board.

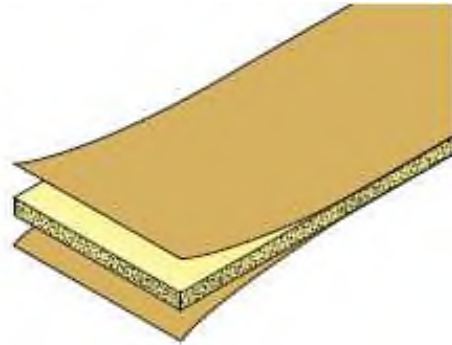

4.2. Symmetry with laminated materials

Obligatory instructions for laminated materials are to be found in the ICDL (International Committee of the Decorative Laminates Industry) guidelines and from the GKV (specialised group on decorative laminated material boards of the General Association of the Plastics Processing Industry, Germany). Not only is the same laminate thickness important but the following are also decisive for optimum symmetry:

- the laminate structure (carrier and decorative papers as well as overlays and protection foils)
- the surface texture
- the graining of the decorative papers
- the direction in which the decorative papers are laid
- the humidity content of the HPL
- the age of the laminates

So never use just pure counterbalancing laminates from any residual stocks or laminated materials with sanded, roughened decor sides for backing the boards. An ideal solution is using decor laminates on

If certain characteristics are essential for certain applications, it is best to contact us. We are constantly expanding our construction program. For more information, please visit us at www.fipro.si.

both sides, i.e. the same laminates for the reverse side as for the decorative side, from the same production (ask for decor laminates «B» quality which may have slight deficiencies in the decor).

5. Pressing procedure

5.1. Choice of adhesive

The decision as to what adhesive to use depends to a large extent on

- the composite material (glue) to the carrier board,
- the area of application,
- the possible gluing procedure (type of press, heating device, glue spreading).

In any case, the regulations concerning fire protection have to be considered the glue also has to be approved

The data in the respective glue manufacturer's instruction sheets are decisive.

5.2. Laminate compression

Apart from general and special cabinet-making rules as well as the instructions of the respective HPL producers, the publications, recommendations and guidelines of the trade associations mentioned under 2.2 also apply. In principle, both procedures are possible.

5.3. Applying the glue

Conventional glue-spreaders can be used roller glue-spreading machines; automatic spray guns

Quantity of glue

You must follow in first place the instructions and recommendations of the glue manufacturer. The exact glue quantities have to be determined by pre-tests.

HANDLING

FIPRO[®] Fire protection boards



5.4. Hot pressing

Under normal circumstances, we do not recommend temperatures above +50 - 60°C. Excessive temperatures and press times cause the glue to harden prematurely. Moreover, high temperatures cause stress in the HPL, which leads to distortions and overstressing of the bond between the carrier board and the HPL.

Pressing times

Depend on type of glue and temperature. Short pressing times are to be preferred but not, however, at the cost of higher temperatures.

5.5. Cold pressing in the block press

Particularly with the hot-pressing procedure, special care must be taken to ensure that the laminated material protrudes of the raw carrier board by no less than 10 mm and no more than 15 mm all round.

Likewise, 10-15 mm must be allowed for trimming all round.

Based on own experience we implicitly prefer the cold-press procedure in the block press, with PVAc glues.

Press temperatures

Press, room and material temperatures should not fall below +20°C.

6. Subsequent treatment

6.1. Curing and rest time

Freshly glued boards are never to be immediately processed, trimmed or cut up. The full strength of the glued surface is reached only after several days.

Even when removing from the press, care must be taken not to flex the boards.

It is crucial that sufficient time be allowed for the glued surface to harden off after pressing. Further processing too soon can lead to problems.

If certain characteristics are essential for certain applications, it is best to contact us. We are constantly expanding our construction program. For more information, please visit us at www.fipro.si.



Mineralka d.o.o.
 SI-1380 Cerknica

T +386.1.709 00 00
 F +386.1.709 00 02

Visit us
www.fipro.si

After cold pressing

It is recommended to leave the boards closely stacked for at least 2 days on an absolutely flat surface, burdened by an approx. 25-30 kg/m² weight.

After hot pressing

Here again, we recommend that the boards be close stacked, on an absolutely flat surface. The boards can cool down slowly under a heat insulating cover. Subsequent processing, such as trimming, cross-cutting, sizing, etc. should take place only after approx. 2-3 days.

Immediately after pressing, the adhesion of the facing materials to the FIPRO boards is not yet complete. Water in glue temporarily weakens the bonding area and the uppermost laminate of the carrier board.

7. Storage of FIPRO boards

The FIPRO boards we supply must be absolutely protected from water and moisture in closed areas and be stored under normal climatic conditions.

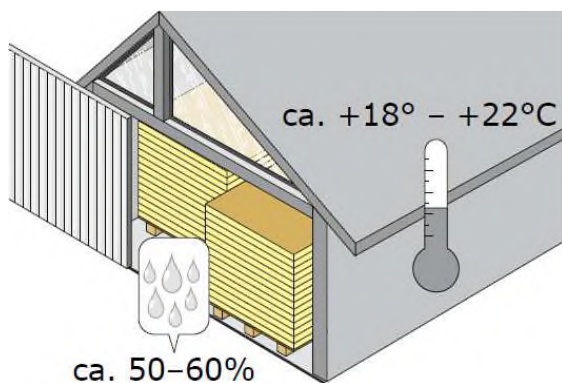

HANDLING

FIPRO[®] Fire protection boards

It is essential to avoid exposing the board to rapid climatic changes.

Boards bonded with HPL may not be exposed to conditions where relative air humidity could drop below 50% or rise above 60%.

Air temperatures in stockrooms should not fall below +18°C and not rise above +22°C. To prevent panels from breaking or deforming, the panels must be stacked on pallets or storage lumber at a span of about 30 cm. Storing the panels upright, without good contact on a supporting surface, will lead to deformation, which causes problems for utilization and installation.

No more than 2 original pallets shall be stacked.

Pallets in use shall be covered by a panel (e.g. thin particle board) and an additional loose film.

If certain characteristics are essential for certain applications, it is best to contact us. We are constantly expanding our construction program. For more information, please visit us at www.fipro.si.